

**ISOTECH**

# Large Volume Stirred Liquid Bath

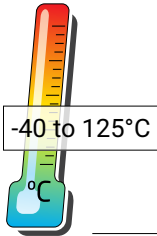

**7980**



# Stirred Liquid Baths

## 7980

- Calibrate a larger number of probes simultaneously
- Specialized for Oceanographic Sensor Calibration
- Option for salt water tanks

The Isotech 7980 Stirred Liquid Bath is an evolution in precision calibration that builds upon the legacy of the Isotech 798 series. This comparison bath is designed to meet the growing demands for high-volume and specialized calibration, including oceanographic sensors, with its expanded calibration volume.

Compared to Isotech's other baths, the large volume of the 7980 allows the calibration of more thermometers and sensors simultaneously. This capability significantly enhances workflow efficiency, especially in environments where high-volume calibration is required.

The 7980 stands out with its precise oceanographic sensor calibration capabilities, enhanced by specialized accessories and additional tanks for saltwater calibration, "Oceanographic Calibration Reservoirs, (OCR)". This adaptability highlights the 7980's versatility in meeting a wide variety of needs. Its energy-efficient design ensures operational cost savings and minimizes environmental impact, aligning with the eco-conscious principles.

Designed to surpass traditional large volume saltwater baths, the 7980 offers faster calibration cycles, essential for time-sensitive processes. This highlights Isotech's commitment to innovation. Supported by Isotech's renowned quality assurance and comprehensive after-sales support, the 7980 delivers reliability, durability, and accuracy, making it a trusted solution for precise temperature control and calibration needs.

Capable of handling a wide range of calibration tasks, the 7980's versatility makes it an invaluable device in laboratories, research institutions, and industries requiring precise temperature calibration.



Its operational efficiency and advanced features solidify its status as a future-proof solution that integrates seamlessly into calibration workflows, providing unmatched performance and reliability. The Isotech 7980 Stirred Liquid Bath sets new standards in calibration technology, offering precision, speed, and an eco-friendly approach to modern calibration challenges.

### ■ Enhanced Calibration Volume

The 7980 version features a larger calibration volume, accommodating more thermometers simultaneously. This improvement addresses customer requests for greater capacity, making the bath ideal for high-volume calibration tasks.

### ■ Isotech Quality and Support

Renowned for quality and reliability, Isotech ensures precise control and stability in temperature calibration, supported by superior after-sales service for a complete calibration solution.

### ■ Oceanographic Sensor Calibration

Specifically designed accessories enable the calibration of oceanographic sensors.

### ■ Faster Calibration

The bath can be equipped with accessories for saltwater calibration, catering to the unique needs of marine science instrumentation, ideal for urgent calibration tasks.

### ■ Versatile Calibration Solutions

The bath's design and accessories support a wide range of calibration options, including those for temperature sensors, oceanographic instruments, and more, providing a versatile tool for diverse calibration needs.

### ■ Enhanced Efficiency Over Large Volume Saltwater Baths

The 7980 significantly accelerates calibration cycles compared to traditional large volume salt water baths. Benefit from reduced energy costs without sacrificing performance.

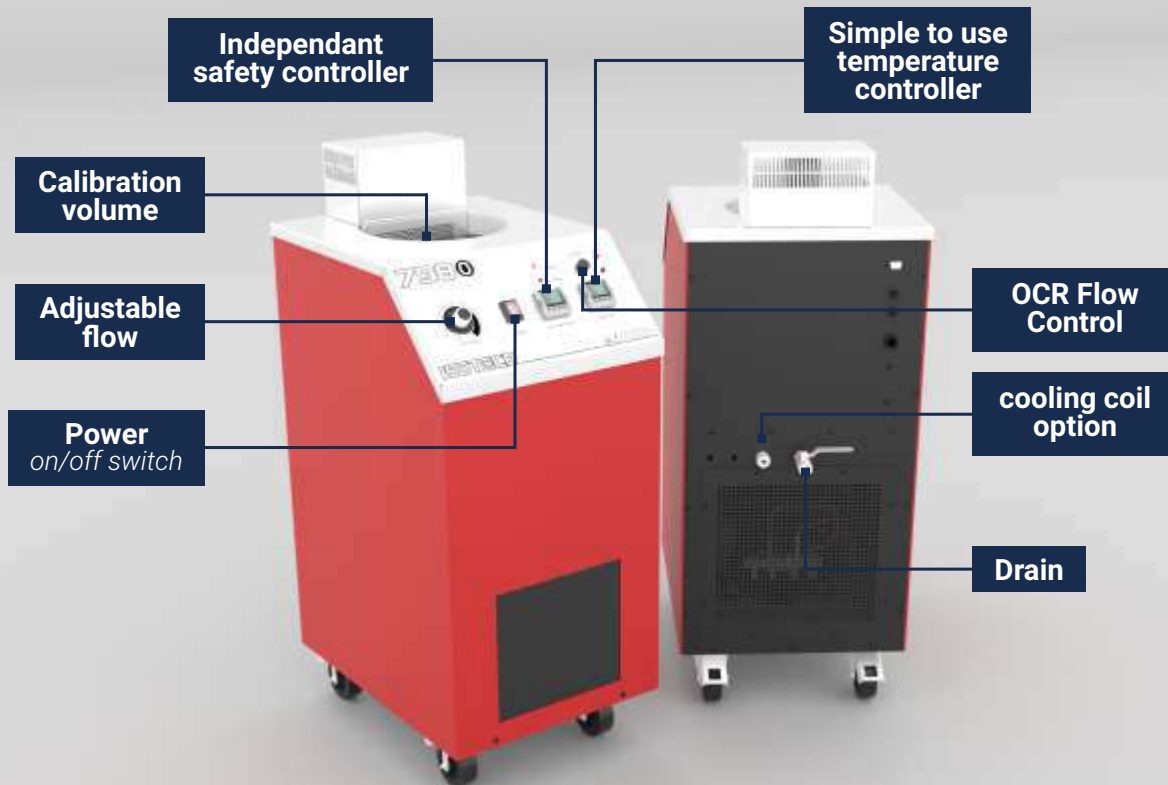

|            |  |
|------------|--|
| Model      | 7980   |
| Temp Range | -40°C to 125°C   |
| Volume     | 7980: 240mm Diameter, 310mm Deep (14 Litres)<br>OCR Salt Water Tank: 226mm Diameter, 250mm Deep (5.3 Litres) |

#### Thermal Performance

|       | 7980 Calibration Volume |            |        | Oceanographic Calibration Reservoir |            |       |        |
|-------|-------------------------|------------|--------|-------------------------------------|------------|-------|--------|
|       | Stability               | Uniformity |        | Stability                           | Uniformity |       |        |
|       |                         | Axial      | Radial |                                     |            | Axial | Radial |
| -40°C | ±0.01°C                 | 0.016      | 0.004  | 0°C                                 | ±0.003°C   | 0.007 | 0.006  |
| -20°C | ±0.008°C                | 0.004      | 0.009  | 50°C                                | ±0.002°C   | 0.002 | 0.005  |
| 0°C   | ±0.008°C                | 0.011      | 0.005  | <b>Extended Range</b>               |            |       |        |
| 20°C  | ±0.008°C                | 0.011      | 0.004  | -40°C                               | ±0.007°C   | 0.015 | 0.003  |
| 50°C  | ±0.003°C                | 0.002      | 0.004  | -20°C                               | ±0.007°C   | 0.017 | 0.003  |
| 125°C | ±0.008°C                | 0.014      | 0.005  |                                     |            |       |        |

|              |  |
|--------------|--|
| Heating Time | 20°C to 125°C < 75 mins  |
| Cooling Time | 125°C to 40°C < 12 hours<br>20°C to 0°C < 120 minutes<br>20°C to -30°C < 300 minutes |

|  |                         |
|--|-------------------------|
| Cooling Time using Internal Cooling Coil | 125°C to 40°C < 3 hours |
|--|-------------------------|

|                |  |
|----------------|--|
| Communications | Includes Serial Interface, PC Cable and Software |
|----------------|--|

|            |  |
|------------|--|
| Dimensions | 405mm Wide, 610mm Deep,<br>980mm High (870mm to Top Panel) |
|------------|--|

|        |      |
|--------|------|
| Weight | 59kg |
|--------|------|

|       |  |
|-------|--|
| Power | 1.5kW<br>110V 50/60Hz or<br>230V 50/60Hz |
|-------|--|

### Cool Down Graph (125°C to 20°C)

In the Calibration Volume

■ using internal cooling coil ■ without

The high efficiency of the insulating foam extends the cooling time from 125°C to ambient temperature. To cool more quickly, water can be passed through a cooling coil, enhancing heat dissipation and speeding up the process.

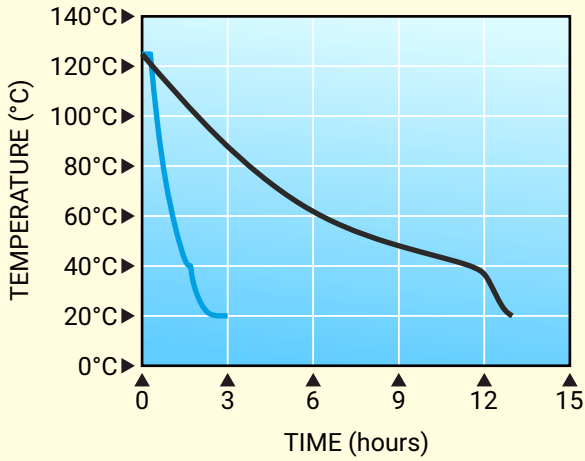

### Heat Up Graph (20°C to 125°C)

In the Calibration Volume

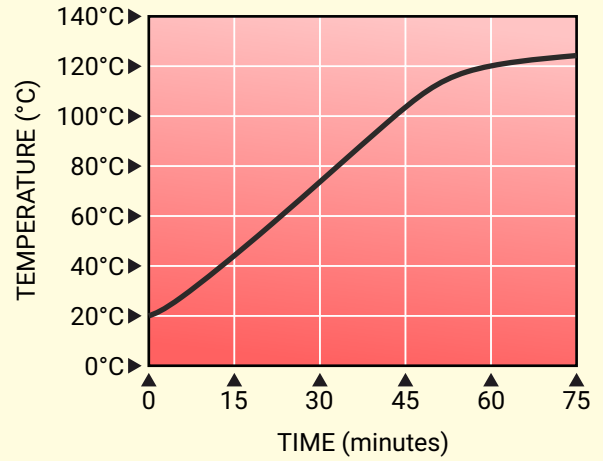

### Cool Down Graph (20°C to -40°C)

In the Calibration Volume

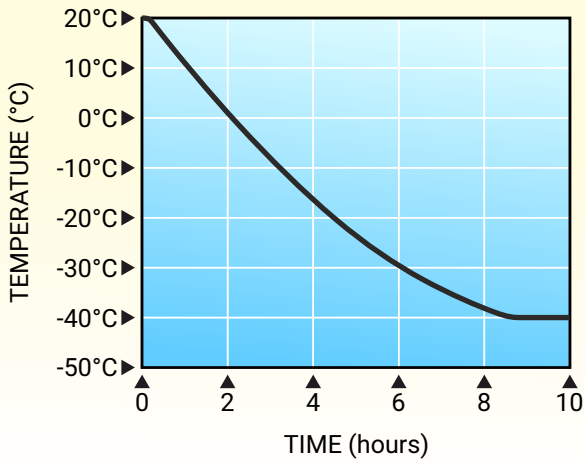

### Cool Down Graph (20°C to 0°C)

In the Oceanographic Calibration Reservoir

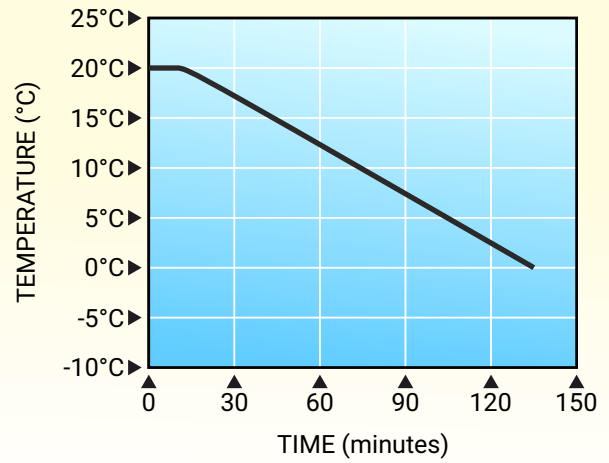

## Volume Comparison with the 798M

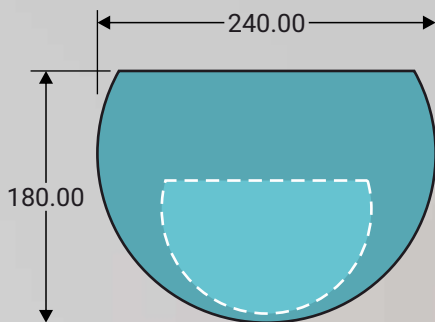

■ 7980 Calibration Area (volume 14 litres)

■ 798M Standard Calibration Area (volume 5 litres)



# Oceanographic Calibration Reservoirs

Introducing the Oceanographic Calibration Reservoirs (OCRs) – a pioneering addition to the Isotech 7980 Stirred Liquid Bath, designed to revolutionize oceanographic sensor calibration. These smaller reservoirs fit into the main calibration volume and can contain salt water for precise probe calibration. The design allows the smaller tank with salt water to sit within the larger volume, enabling it to be quickly cooled to 0°C without ice formation. This benefits the user with fast cooldown times and significant energy and cost savings compared to using large-volume saltwater tanks.

## Seawater Compatibility

Designed with seawater-compatible materials, the OCRs ensure durability and corrosion resistance, offering a realistic calibration environment for accurately simulating marine conditions, providing a realistic calibration environment for marine sensors.

## Precision Calibration

Designed to integrate seamlessly with the Isotech 7980, the OCRs offer a controlled calibration space that enhances the precision of temperature measurements for oceanographic sensors.

## Speed

Using the smaller OCR in the 7980 allows for rapid cooling without ice formation and also fast heating with reduced energy costs.

*Using the smaller OCR in the 7980 allows for rapid cooling without ice formation and fast heating with reduced energy costs*



## Oceanographic Calibration Reservoirs Specifications

The standard OCR is designed for up to four oceanographic probes (maximum diameter 40mm) to be suspended from the lid. Alternatively special OCRs can be designed to suit your specific probe(s), please contact Isotech for more details.

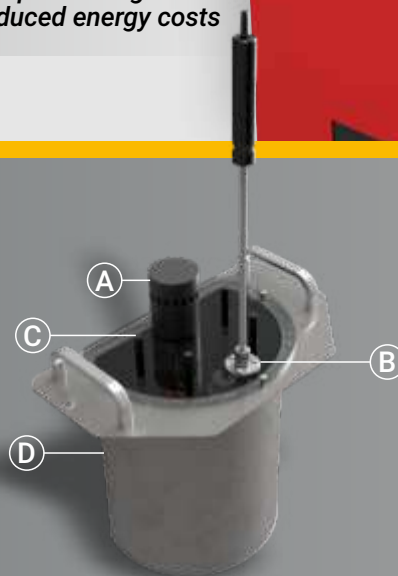

- A: OCR Stirrer Motor
- B: Reference Probe Clamp
- C: Oceanographic Sensor
- D: Saltwater Reservoir

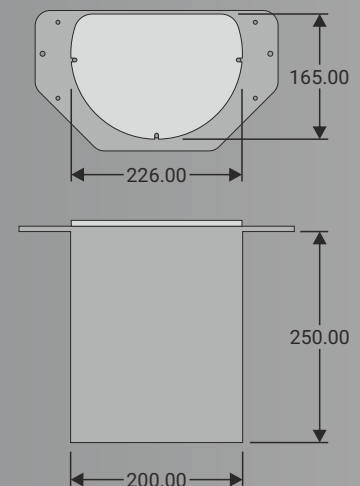

| Parameter         | OCR  |
|-------------------|--|
| Model             | 798-OCR-A<br>(Up to 4 probes of up to 40mm diameter)<br>798-OCR-S<br>(Special, contact Isotech for more details) |
| Temperature Range | 0°C to 50°C  |
| Volume            | 5.3 Litres   |

For successful temperature calibration  
you need more than just a liquid bath...  
**Trust Isotech for the complete solution**



## milliK Precision Thermometer

- Supports a Wide Range of Sensors
- High Accuracy
- Logs and Controls Isotech Temperature Sources Massive logging capacity

The milliK Precision Thermometer from Isotech sets a new standard for the high accuracy measurement and calibration of Platinum Resistance Thermometers, Thermistors, Thermocouple and Process Instrumentation (4-20mA) over the range -270°C to 1820°C.

The milliK has two input channels for sensors and a third channel for current. It can be expanded to become a measuring system with up to 33 channels reading SPRTs, RTDs, Thermistors, or Thermocouples with the option to control calibration baths and log readings accurately.



## microK Precision Thermometry Bridge

- Ratio Accuracy to <math><0.02\text{ppm}</math> (20ppb) with Zero Drift
- SPRTs, PRTs, RTDs, Thermistors and Thermocouples
- Reliable 21st Century 100% Solid State Design

The microK models are designed for both Primary and Secondary Temperature Laboratories, as well as a wide range of high-accuracy industrial and scientific calibration applications. These instruments use a completely new measurement technique to achieve accuracies better than 0.02 parts per million (ppm).

When used with a 0°C cold junction reference unit, or by measuring the junction temperature with a PRT on another channel the instrument is capable of low uncertainty precision thermocouple measurements, with a voltage uncertainty of just 0.25 $\mu\text{V}$ , equivalent to 0.01°C with a Platinum/Gold Thermocouple at 1000°C.



# Measuring System & Automation Software

- Fully automatic calibration
- Design and print certificates
- Calculate coefficients

Use I-Cal Easy to automate sensor calibration, enter up to 20 calibration points and let the software set the calibrator, wait for stability and log the data automatically. Choose the stability criteria and how many points to record at each calibration temperature. Automatic temperature calibration the easy way.

I-Cal Easy lets you use a built-in template or design your own certificate. Add text, data fields and graphics on single or multiple pages, then publish the calibration data to the certificate.

Do you want to include or calculate coefficients? Then drag your data to the ITS-90 or Calender Van Duesen calculators.

For thermocouples use the powerful regression calculator to fit error curves.



# Model 909 SPRT

- Three Stem Lengths
- Wide Operating Range
- Proven Design

This economically-priced Standard Platinum Resistance Thermometer, Model 909, is the workhorse of calibration laboratories all over the world. During 2007 we reviewed our range of SPRTs and now have new models in the 909 family, the 909L and 909H. The wide temperature ranges and economic pricing make this thermometer ideal for the secondary laboratory. For smaller uncertainties to suit the Primary Laboratory refer to the Model 670 SPRTs.



# Semi Standard PRTs

- High Accuracy, -200°C to 660°C
- Working Standards In Dry Blocks and Liquid Baths
- Field and Laboratory Use

These Industrial Platinum Resistance Thermometers (IPRT / PRT) are ideal for field and lab use. Suitable for use as working standards in Dry Blocks and Liquid Baths or as high accuracy probes for our range of True Temperature Indicators.

All the thermometers are metal sheathed and both less fragile, and more affordable than the Isotech range of true Standard Platinum Resistance Thermometers that are used in laboratories and our found in our publication "Solutions for Primary and Secondary Laboratories".



# Jarrett-Isotech Water Triple Point Cells

- Fifty Years of Proven Use
- Uncertainty 0.000070°C
- Quartz Glass and Isotopic Analysis Available

The Water Triple Point is the most important fixed point, the only point common to the ITS-90 and the Thermodynamic Temperature Scale. It is an essential reference point for every temperature laboratory. The Jarrett-Isotech cells are the best standard, all cells are not the same, accept no inferior device.





## About Us

The world leader in temperature metrology, with over 40 years' experience.

Our clients include the world's leading laboratories including National Laboratories, leading ISO 17025 Accredited Laboratories and users in all industries.

## Why Choose Isotech?

- Isotech has solutions for all calibration needs, from Primary Laboratories maintaining National Standards to the needs of field engineers calibrating industrial sensors on site. Isotech is truly "The Source for Calibration Professionals".
- Global Network - local support. Isotech has over 90 authorized sales agents worldwide! No matter where you are, we can offer local support.
- The world's leading National Metrology Institutes choose Isotech - shouldn't you?



**As a leading thermocouple manufacturer, it's crucial for us to check with the utmost precision. Isotech equipment consistently provides the accurate measurements we rely on. We've partnered with Isotech for over 30 years, appreciating not just their high-accuracy products but also their exceptional customer service, insightful advice, and genuine feedback.**



*Stephen Holt, Technical & Quality Manager, Scott Precision Wire Ltd*

Temperature Metrology Solutions for:

- ITS-90 Primary Standards
- Industrial Sensor Calibration
- Secondary Temperature Calibration
- Infrared Thermometers
- High Accuracy Temperature Measurement
- Thermocouple Referencing Equipment

**ISO 17025 calibration services to the smallest of uncertainties and with international recognition**



**Find out more on our Website**

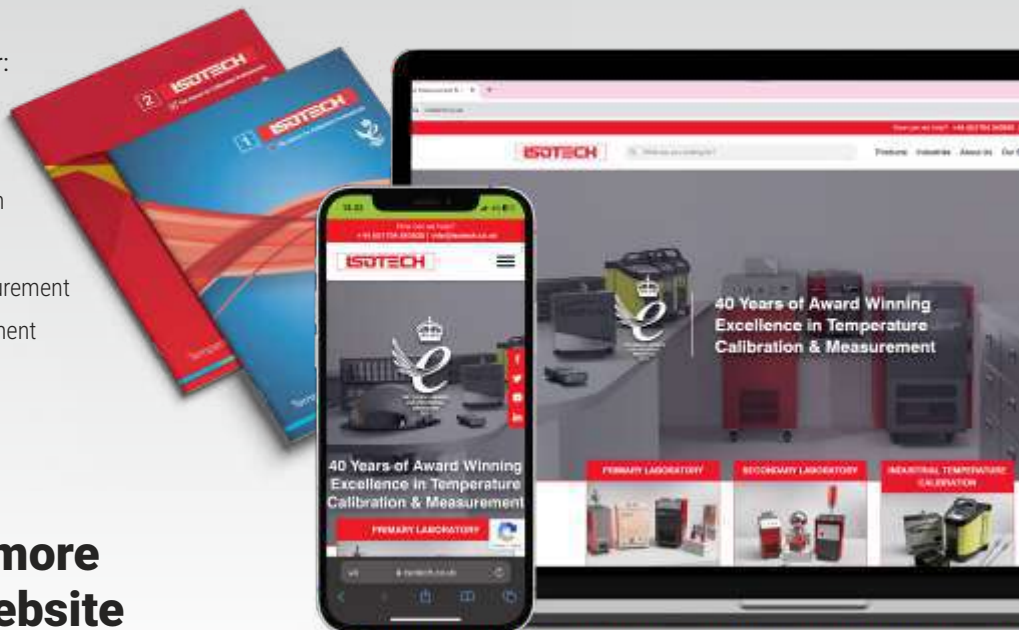

Telephone: +44 (0)1704 543830

Email: [info@isotech.co.uk](mailto:info@isotech.co.uk) Web: [www.isotech.co.uk](http://www.isotech.co.uk)

Isothermal Technology Limited Pine Grove, Southport, Merseyside PR9 9AG England